

Product Description

LikoStretch Mod 600 IC equipped with Straps is intended for horizontal lifting and transfer in extra demanding lifting situations. The lift straps are comfortably placed under the patient without having to turn or roll the patient. LikoStretch Mod 600 IC can also be equipped with LiftSheets made of plastic coated net.

LikoStretch Mod 600 IC is available in two designs with

different widths: Standard (70 cm/27.5 in.), and Wide (80 cm/31.5 in.).

LikoStretch Mod 600 IC can be used together with a number of Liko's lifts such as the stationary lifts Likorall, Multirall, Liko MasterLift and the mobile lifts Viking L, Viking XL and Golvo.

In this document, the person being lifted is referred to as the patient and the person helping is referred to as the caregiver.

△ is a warning triangle used for situations that demand extra care and attention.

IMPORTANT!

Read the instruction guide for both the patient lift and lifting accessories before use. Lifting and transferring a person always involves a certain level of risk. It is important to completely understand the contents of the instruction guides. The equipment should only be used by trained personnel. Please contact Liko/Hill-Rom in the event of any uncertainties or questions.

Table of Contents

Safety Instructions	2
Definitions	3
Maximum Load	3
Recommended Lifting Accessories	3
Assembly	5
Lifting with Straps	6
Lifting with LiftSheet	8
Adjusting the centre of gravity during lifting with LiftStraps/LiftSheet	9
Care and Maintenance	10

△ NOTE!

This instruction guide contains important information for the user of the product. All those who use the product should review and completely understand the contents of the instruction guide. Remember to keep the instruction guide in a place where it is always available to those using the product.

Safety Instructions

△ Before lifting, remember the following:

- Ensure that the lifting accessory is properly attached to the lift.
- Read the instruction guides for the lift and lifting accessories.
- Make sure that personnel using the lift are informed of the correct operation and use of the lift.
- We recommend that at least two persons assist during lifting with LikoStretch Mod 600 IC.
- Plan the lifting operation before the lift to make it as safe and comfortable as possible.
- Make sure that any castors on beds, gurney, etc., are locked during lifting/transferring operation. However, the mobile lift's castors should be unlocked when it is used with the stretcher.
- Before the patient is lifted from the underlying surface, but when the straps have been fully extended, make sure that the lift straps are properly connected to the stretcher.
- Because LikoStretch Mod 600 IC has self-locking lift straps, the patient must rest completely on a solid surface before the lift straps are loosened.

△ Never leave a patient unattended during a lifting situation.



LikoStretch Mod 600 IC complies with the requirements for Class 1 products (MDD 93/43/EEC). LikoStretch Mod 600 IC meets requirements with respect to EN ISO 10535:2006.

△ The stretcher must not be modified under any circumstance. If you have any questions, please contact Liko/Hill-Rom.

Max. load: 250 kg (550 lbs).

Definitions

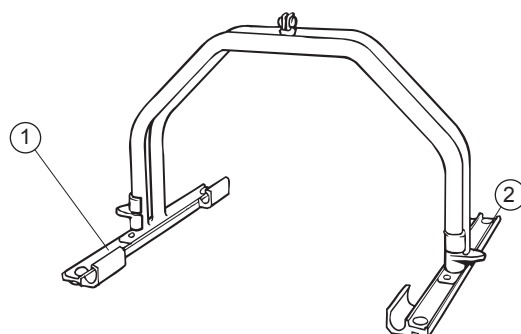

1. Lift rail
2. Safety catch

LikoStretch Mod 600 IC is available in two designs.

LikoStretch Mod 600 IC, standard

Width 70 cm (27.5 in.)

Max. 250 kg (550 lbs)

Prod. No. 3156065

LikoStretch Mod 600 IC, wide

Wide 80 cm (31.5 in.)

Max. 250 kg (550 lbs)

Prod. No. 3156065B

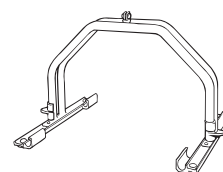

A complete lift system requires the following lifting accessories: SideRails, Straps alternatively LiftSheet.
See *Recommended lifting accessories* page 3-4.

Maximum Load

Different maximum allowable loads may apply to different products on the assembled lift system depending on: the design of the LikoStretch mod 600 IC and which lifting accessories being used. For the total lift system, the lowest maximum allowable load indicated for the respective products on the lift system always applies. For example: LikoStretch Mod 600 IC, has a max. load of 250 kg. In combination with Quick-release Hook Universal which has a max. load of 300 kg the applicable max. load is 250 kg for the total lift system.

Study the markings on the lift and lifting accessories or contact your Liko/Hill-Rom representative if you have any questions.

Recommended Lifting Accessories

SideRails 600 (pair)

Fits all models. To be combined with Straps.

Max. 250 kg (550 lbs)

Prod. No. 3166506



Straps Mod 600 IC, 8 pcs/set

Polyester.

Max. 250 kg (550 lbs) irrespective of how many of the straps (6-8 pcs.) that are being used.

Prod. No. 3684001

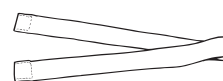

Spatula Mod 600 IC

Enables easy and convenient placing of Straps.

Prod. No. 3684002



LiftSheet 800, standard

Width 80 cm (31.5 in.), length 80 cm (31.5 in.), plastic coated fabric. Fits LikoStretch Mod 600 IC, Standard.
Max. 250 kg (550 lbs)

Prod. No. 3682504

**LiftSheet 1800, standard**

Width 80 cm (31.5 in.), length 180 cm (71 in.), plastic coated fabric. Fits LikoStretch Mod 600 IC, Standard.
Max. 250 kg (550 lbs)

Prod. No. 3682509

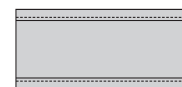
**LiftSheet 1800, wide**

Width 90 cm (35.5 in.), length 180 cm (71 in.), plastic coated fabric. Fits LikoStretch Mod 600 IC, Wide.
Max. 250 kg (550 lbs)

Prod. No. 3682508

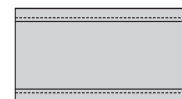
**Solo LiftSheet 1800**

Width 90 cm (35.5 in.), length 180 cm (71 in.), 2x10 pcs, Non-woven material. Not washable.
Fits LikoStretch Mod. 600 IC Wide.
Max. 200 kg (440 lbs)

Prod. No. 3682908-2

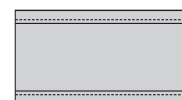
**SideRails 800 (pair)**

Fits LiftSheet 800, standard.
Max. 250 kg (550 lbs)

Prod. No. 3166508

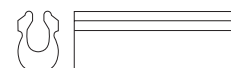
**SideRails 1800 (pair)**

Fits LiftSheet 1800 standard, LiftSheet 1800 wide and Solo LiftSheet 1800.
Max. 250 kg (550 lbs)

Prod. No. 3166518

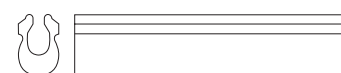
**Stretch Leveller**

Recommended accessory for balancing the centre of gravity during lifting.
Max. 300 kg (660 lbs)

Prod. No. 3156200

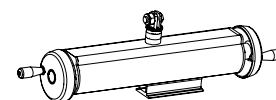
**Mast Attachment**

Golvo Mast Attachment for LikoStretch Mod 600 IC. Includes 4 straps. Recommended when LikoStretch Mod 600 IC is used in combination with mobile lift Golvo in situations requiring increased stability during the lifting operation.

Prod. No. 2001600

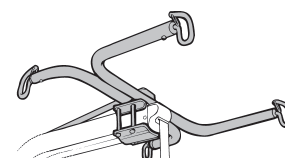

4 x

Quick-release Hook TDM

Liko's Quick-release Hook TDM is part of a system that enables quick and easy exchange of lifting accessories on Liko's mobile and stationary lifts. See "Guide to Liko's Quick-release Hook System", which can be downloaded from our website www.liko.com, or contact Liko/Hill-Rom for more information about the advantages and use of the Quick-release Hook system.
Max. 300 kg (660 lbs)

Prod. No. 3156502

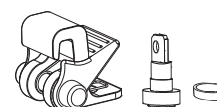
**Adapter 12 mm**

Max. 300 kg (660 lbs)

Prod. No. 2016504

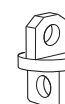
**Scale**

In need of weighing persons in combination with LikoStretch Mod 600 IC, we recommend LikoScale 350 (adapter 2016504 is required).
LikoScale 350 is certified according to the European Directive NAWI 90/384 (Non Automatic Weighing Instruments).
Contact Liko/Hill-Rom for further information.

Prod. No 3156228

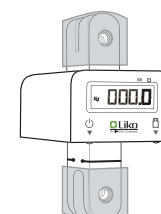

Assembly

Fixed assembly

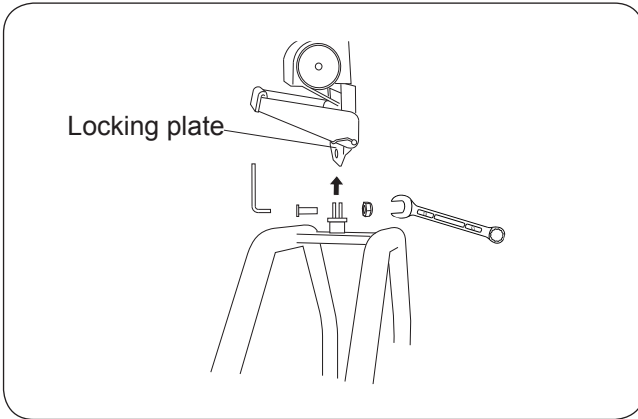

Liko MasterLift, Likorall (not R2R) and Golvo
LikoStretch Mod 600 IC is assembled directly into the lift's locking plate using M10x25 screws and nuts.
Recommended tools: 6 mm Allen wrench and 17 mm closed-end wrench.

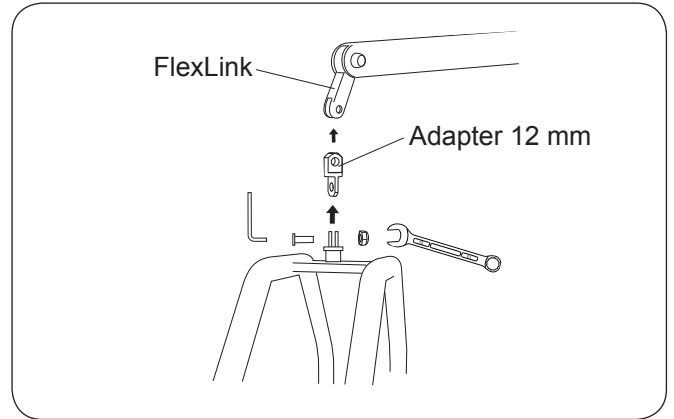

Viking L, Viking XL
LikoStretch Mod 600 IC is assembled via the accessory Adapter 12 mm (see page 4) using M10x25 screws and nuts.
Recommended tools: 6 mm Allen wrench and 17 mm closed-end wrench.

Assembly with Quick-release Hook

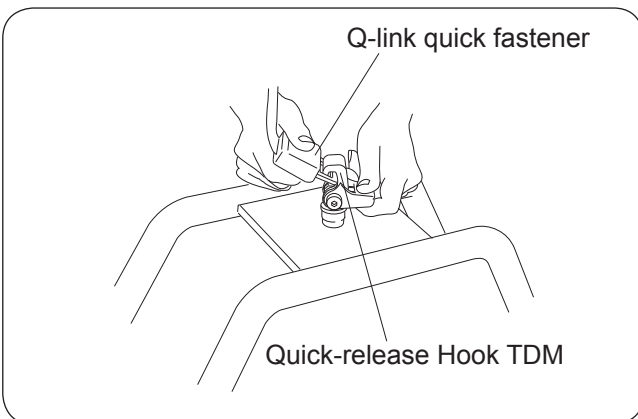

LikoStretch Mod 600 IC may be equipped with Quick-release Hook TDM (see page 4) to enable smooth and easy assembling into the lift without tools.

The lift must be equipped with Q-link quick fastener in order to fit the Quick-release Hook TDM. Some lifts in Liko's product range (Multirall, Likorall R2R) include this as a standard feature, whereas other lifts intended for use with LikoStretch Mod 600 IC may be complemented with Q-link quick fastener as an additional option.

Lifting with Straps

Place the carrying straps under the body in desired positions; the number of straps required is to be determined by the responsible nursing staff from case to case (see alternatives below). For safety reasons, LikoStretch Mod 600 IC is designed so that the lift straps self-lock when load is applied to correctly attached straps. Therefore, the patient must be lowered to the bed before the straps can be loosened and moved.

6 straps

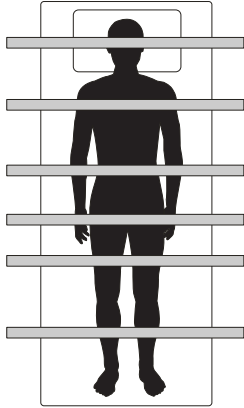

7 straps

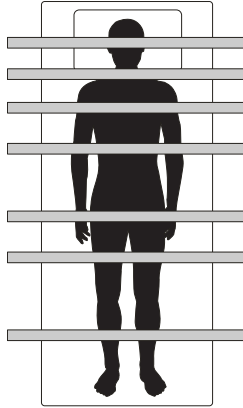

8 straps

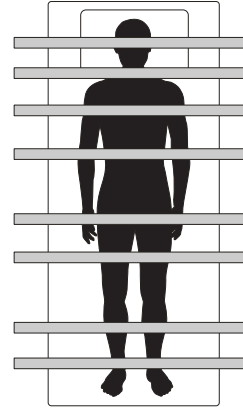

Begin by laying out the straps above the positions on the body where the straps will subsequently lift.

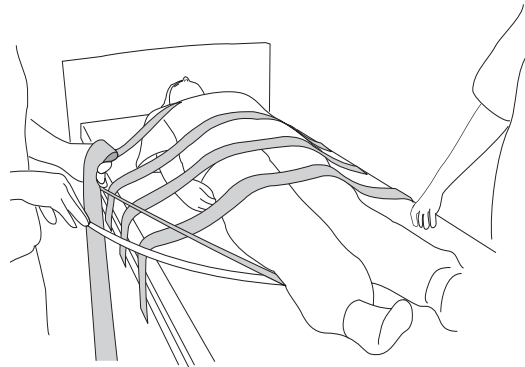
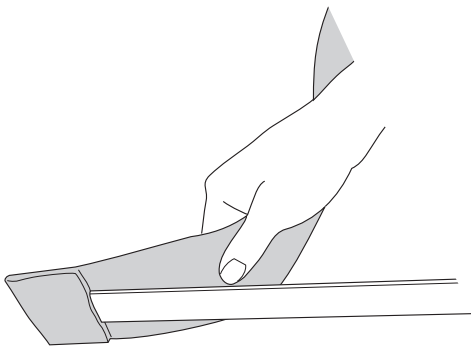

Thread the spatula into the little pocket on the strap. Turn the strap so that the pocket faces downward. Positioning the straps is much easier if the surface/bed sheet is taut and even.

Place the straps under the patient using the spatula. Hold the strap about 40° from the bed and carefully push the spatula diagonally downward and inward.

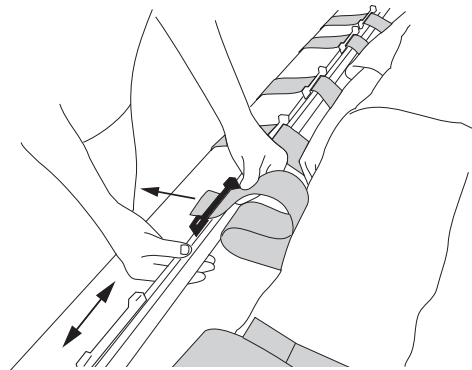
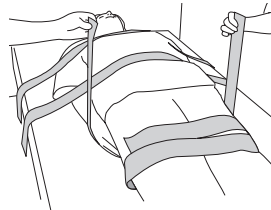
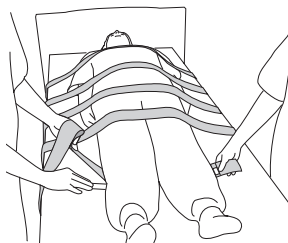

Grasp the strap on the opposite side and pull it out so that it is equally long on both sides. As each strap is positioned, arrange the strap ends on top of the patient.

Remove the SideRails and thread the straps through the strap locks, as illustrated. **NOTE! Always begin by threading the straps from the head end downwards.** The strap locks can slide sideways to correspond to the position of the lift straps.

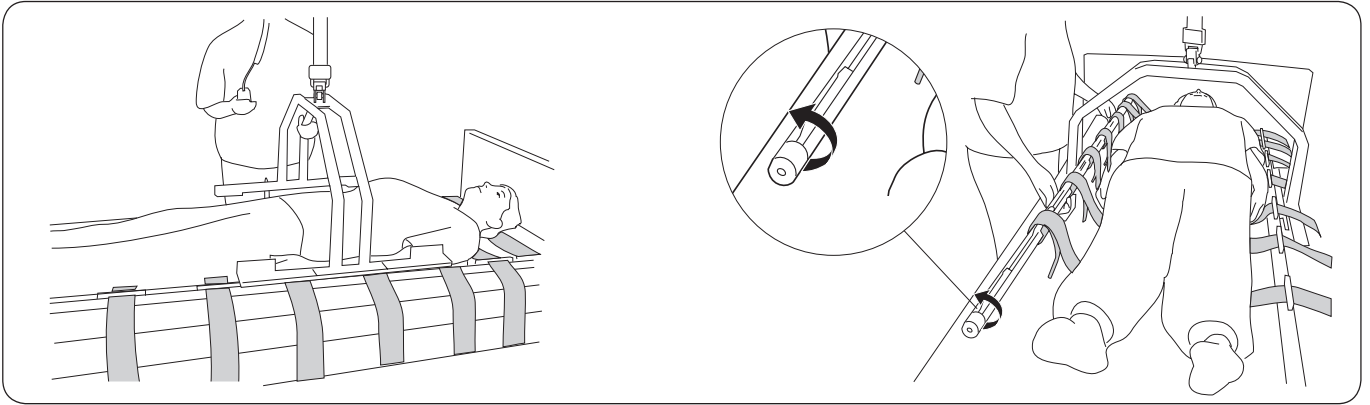

Lower the stretcher to the bed right above the patient's centre of gravity, usually just below the navel.

Pull the SideRail towards you. Then twist the SideRail one whole turn (360°), as shown in the illustration.
NOTE! The strap ends are then under the straps.

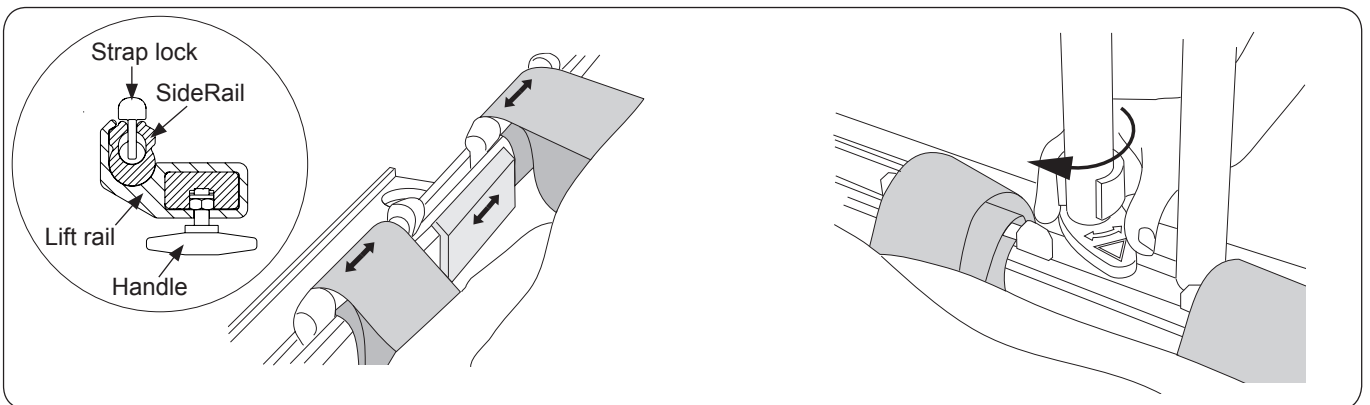

Place the SideRails in the stretcher's lift rail so that they lock in position. Make sure that the lift straps do not get jammed between the lift rail and the SideRail; if so, adjust the lift rail with the handle on the under side or reposition the lift strap.

Turn the red safety catch in over the SideRail. (Note that even a partial turning, i.e. less than 180°, will secure the SideRail from being unhooked unintentionally.)

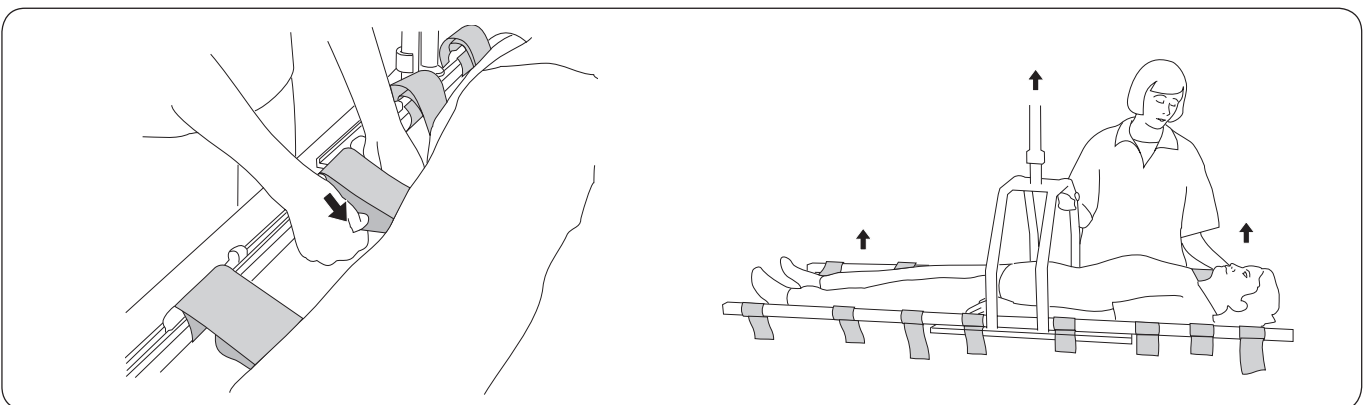

Tighten each LiftStrap by pulling the strap end inwards – slightly downwards towards the patient, as shown in the illustration.

Lifting can begin. Check to ensure that the patient is suspended in desired position, i.e. horizontally or normally with the head slightly higher. See *Adjusting the centre of gravity during lifting with LiftStrap/ LiftSheet* page 9.



When lifting has been completed, remove the LiftStraps according to the description below.

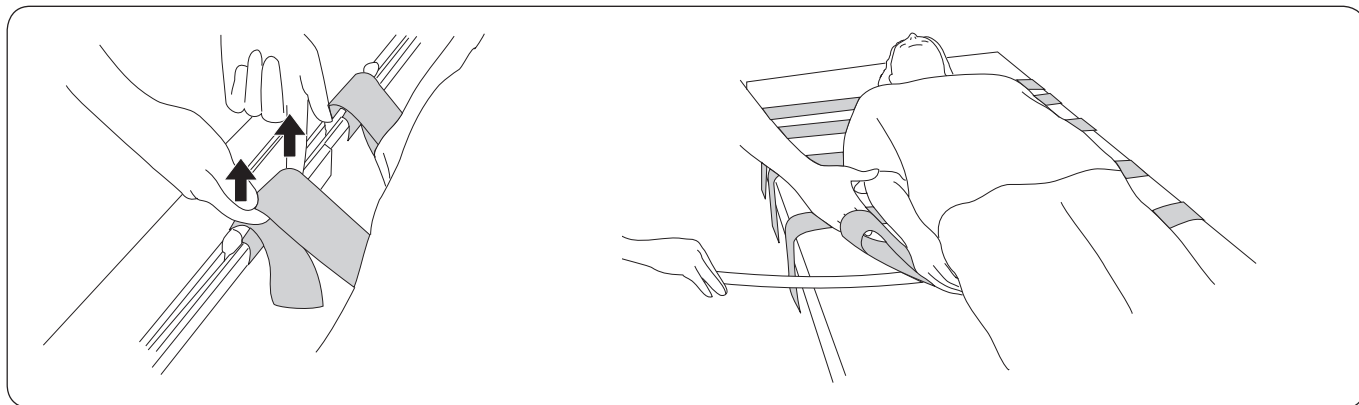

Lower the patient to a solid base. Loosen the lift straps by lifting straight up, as shown in the picture. When all the lift straps have been loosened the SideRail can be unhooked and removed. Remember to turn back the safety catch so that it is at a 90° angle in relation to the lift rail.

Remove the lift straps by carefully guiding them under the patient with the help of the spatula. For least friction push the strap ends under the lift straps themselves. Alternatively, gently pull the lift straps out from under the patient without the spatula.

Lifting with LiftSheet

For lifting with LiftSheet, Liko recommends LiftSheet 1800 or shorter and corresponding length of SideRails. See *Recommended lifting accessories* page 3-4.

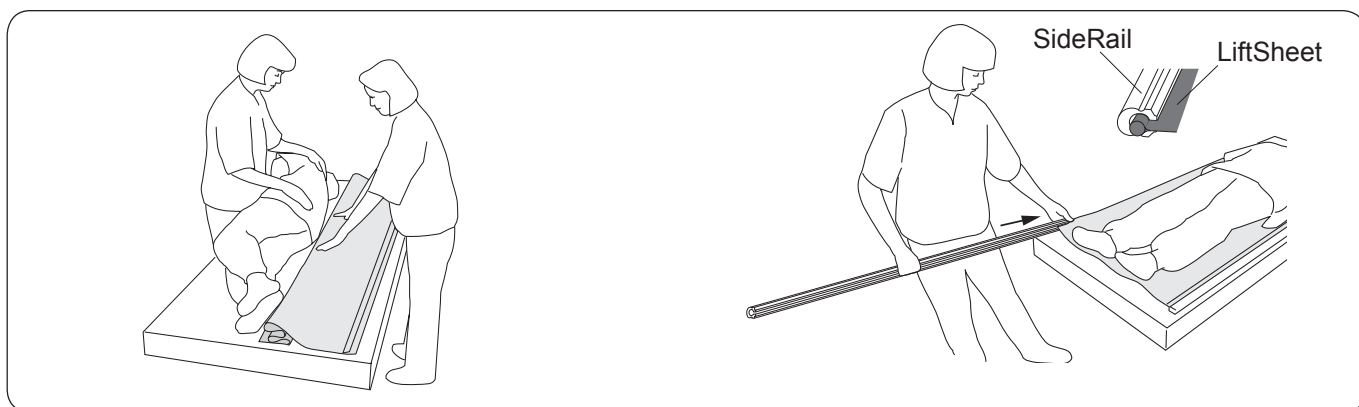

Turn the patient on his/her side. Lay the liftSheet's long side with the loose flap facing upwards, as far under the patient as possible. Then fold the sheet over a couple of times to ensure that it is evenly distributed under the body. Turn the patient back on his/her back. Carefully pull the LiftSheet into place under the patient.

Thread the SideRails over the edge of the liftSheet's long sides.

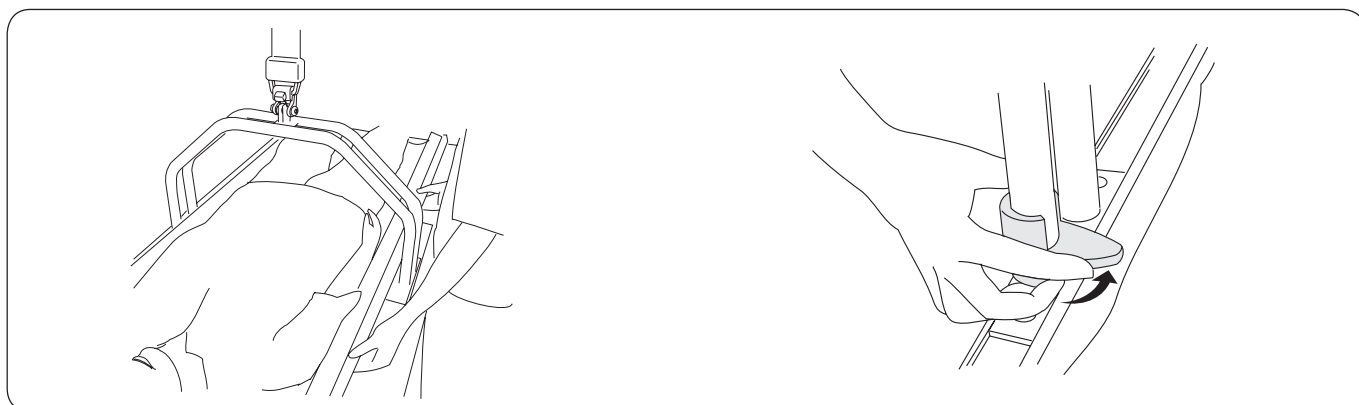

Lower the stretcher to the bed directly above the patient's centre of gravity, usually just below the navel. Place the SideRails in the lift rails so that they lock in position when load is applied to the LiftSheet.

Turn the red safety catch 180° in over the SideRail.



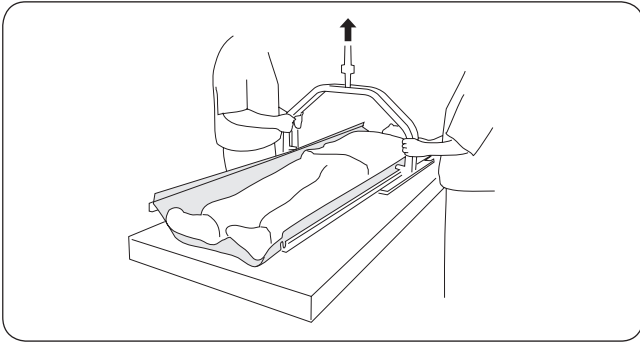

Lifting can begin. Check to ensure that the patient is balanced when suspended and preferably with the head a little higher.

See *Adjusting centre of gravity during lifting with LiftStrap/LiftSheet* page 9.

When lifting has been completed, remove the LiftSheet according to the description below.

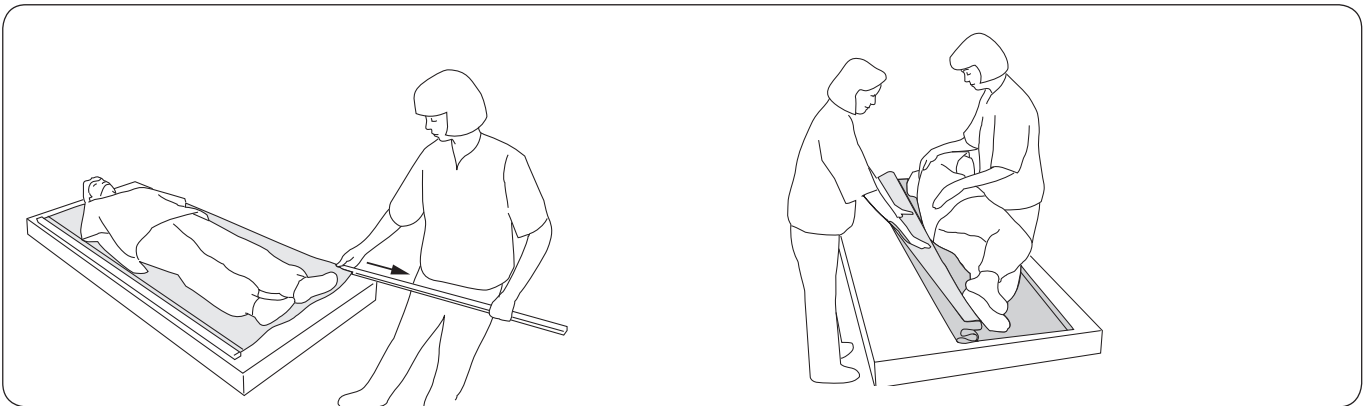

△ Remove the SideRails before removing the LiftSheet so that they do not become caught under the patient when turning him/her.

Turn the patient on his/her side. Lay the LiftSheet in evenly distributed folds under the patient. Turn the patient back on his/her back again and carefully pull out the LiftSheet.

Adjusting the centre of gravity during lifting with LiftStraps/LiftSheet

By adjusting the position of the stretcher.

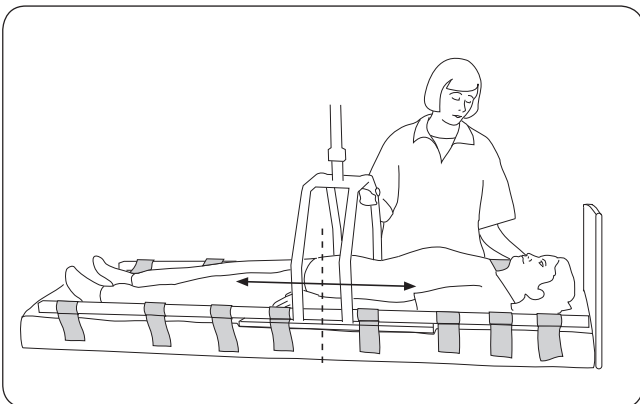

If the patient is not balanced during lifting, adjust this by lowering the patient onto a solid base so that weight can be relieved from the straps. In this position the SideRails can be moved along the stretcher's lift rail in order to achieve the correct balance.

With the lifting accessory Stretch Leveller

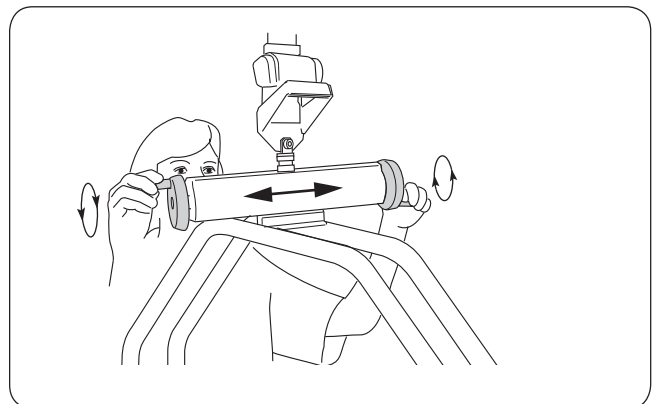

With the Stretch Leveller (see page 4) the centre of gravity can be easily regulated while the patient is in an elevated position (lifted) by turning the knobs on the Stretch Leveller.

Care and Maintenance

Care and Maintenance

For trouble-free use, certain details should be checked each day the stretcher is used:

- inspect the stretcher and lifting accessories to make sure that there is no external damage
- check that the safety catches are functioning.

When necessary, clean the stretcher with a moist cloth, using warm water or disinfectants.

NOTE! Do not use cleaning agents that contain phenol or chlorine, since these can damage aluminum and polyamide material.

△ **The stretcher should not be exposed to running water.**

The stretcher must be inspected at least once per year. See Liko's protocol for periodic inspection.

△ IMPORTANT!

Repairs and maintenance may only be carried out by authorized Liko service personnel using original Liko spare parts.

Service Agreement

Liko/Hill-Rom offers the opportunity to enter into service contracts for the maintenance and regular inspection of your Liko product. Contact your Liko/Hill-Rom representative for more information.

Expected Life Time

The product has an expected service life of 10 years when correctly handled, serviced and periodically inspected in accordance with Liko's instructions.

Transport and Storage

The environment in which the stretcher is transported and stored should have a temperature of 10–40 °C and a relative humidity of 30–75 %. The air pressure should be 700–1060 hPa.

Recycling

For instructions on how to recycle your Liko product, please visit our website: www.liko.com.

Product Changes

Liko's products undergo continuous development, which is why we reserve the right to make product changes without prior notice. Contact your Liko/Hill-Rom representative for advice and information about product upgrades.

Design and Quality by Liko in Sweden

Liko is quality-certified in accordance with ISO 9001 and its equivalent for the medical device industry, ISO 13485. Liko is also certified in accordance with environmental standard ISO 14001.



A  Company

www.liko.com

Manufacturer:

Liko AB
Nedre vägen 100
SE-975 92 Luleå
Sweden
info@liko.se